



# VERTICAL ILLUSION

Architectural  
**HANDBOOK**  
[WWW.VERTICALILLUSION.COM](http://WWW.VERTICALILLUSION.COM)

2514 E Mohawk Lane Suite 103 Phoenix, AZ 85050  
602-788-0662





## TABLE OF CONTENTS

- 4** SHAPES
- 18** FINISHES
- 27** HOW TO SPECIFY
- 30** ACCESSORIES
- 31** INSTALLATION INSTRUCTIONS
- 35** CARE
- 36** TERMS & CONDITIONS
- 37** WARRANTY
- 38** SAFETY
- 39** GALLERY

# VERTICAL ILLUSION

# SHAPES

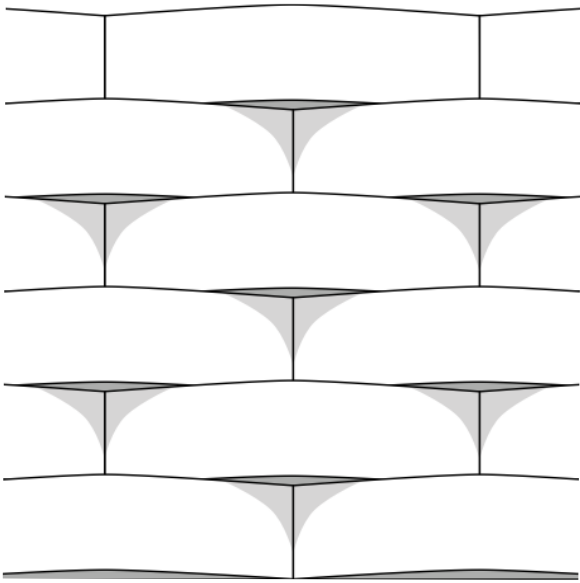

Convex

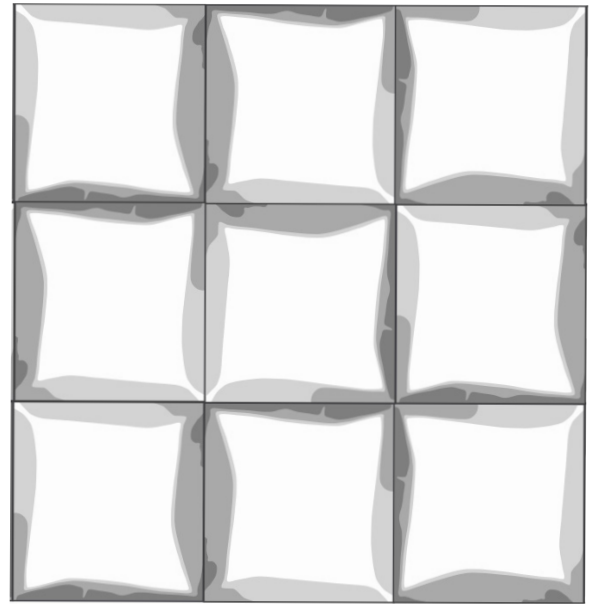

Quad



Slant

**VERTICAL**  
ILLUSION

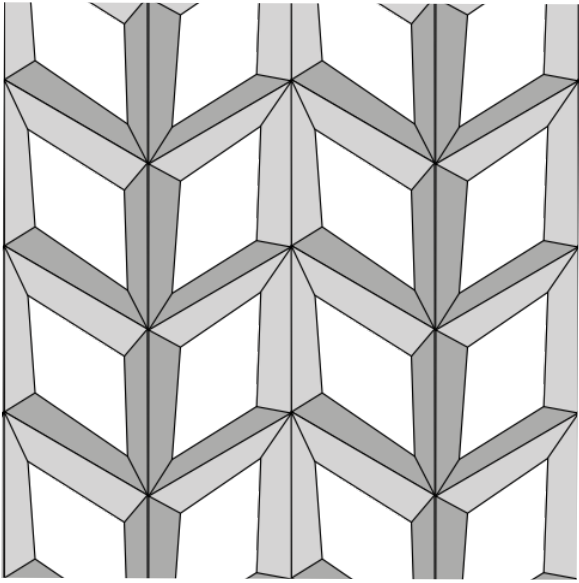

**Rhom**

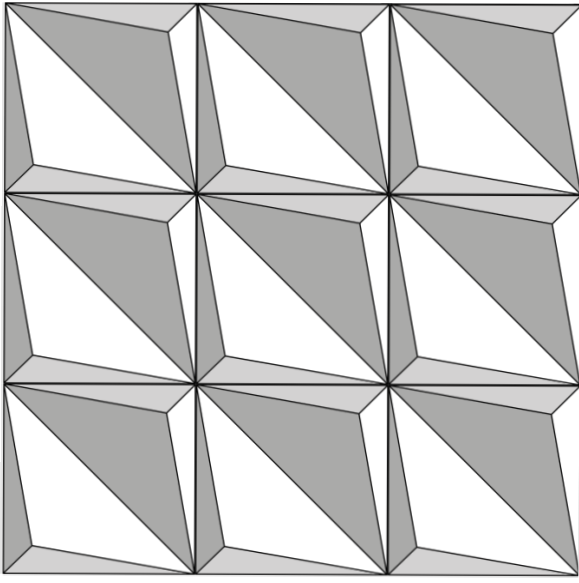

**Vale**

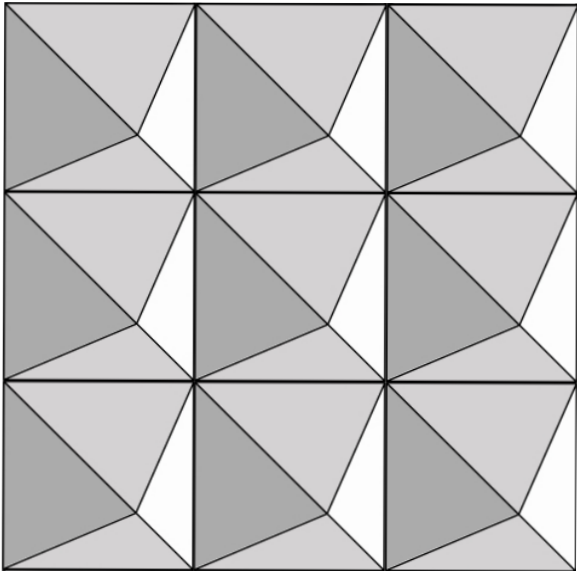

**Vertex**

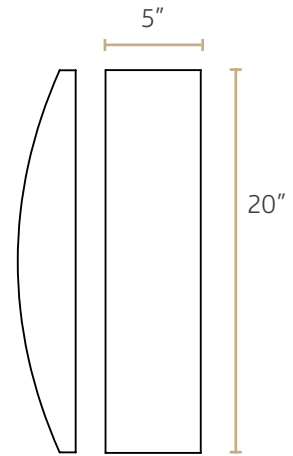
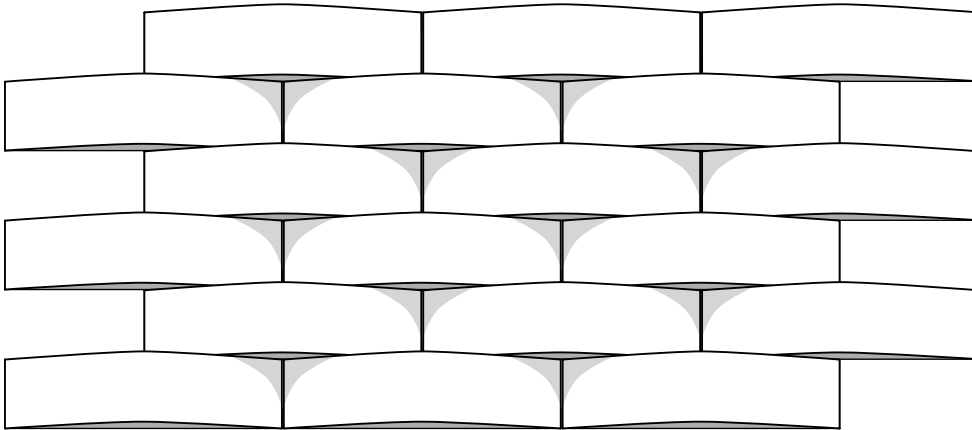

## Product Specifications

- > **COVERAGE/TILE**  
.70 sf
- > **THICKNESS**  
7/16" to 1.5"
- > **WEIGHT/CASE**  
24 lbs
- > **COVERAGE/CASE**  
16.8 sf
- > **WEIGHT/TILE**  
1 lb
- > **INSTALLATION**  
For best results, download installation instructions at [www.verticalillusion.com](http://www.verticalillusion.com)
- > **TILE SIZE**  
5" x 20"
- > **TILE/CASE**  
24

### PRODUCT SAMPLE DISCLAIMER

Created to be a one-of-a-kind piece of nature's artistry, each and every Vertical Illusion® product carries distinct variations in finish, patina, texture, grain and overall character that create the unique diversity and natural elegance of our wall coverings. It is virtually impossible to capture – in a small sample – the entire range of color variation and character that will be present in the wall covering you will receive. To better understand the unique look of a Vertical Illusion finished wall covering in your space, we recommend consulting your sales representative for more details.

### INSTALLATION AND PERFORMANCE DISCLAIMER

Environmental conditions, such as exposure to light, and fluctuations in temperature and humidity, will greatly affect product performance from initial installation throughout its life. Refer to our website for installation guidelines or see your local sales representative for more information on proper steps and specific environmental conditions to successfully install, care for and ensure the lifelong performance of your wall covering.

Make it your Own! This tile has a variety of layout options. Here are some suggested installations.

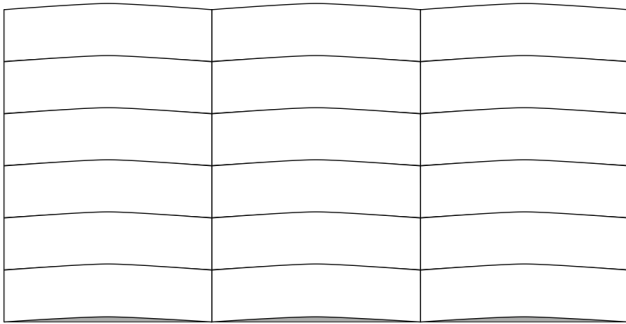

Straightset

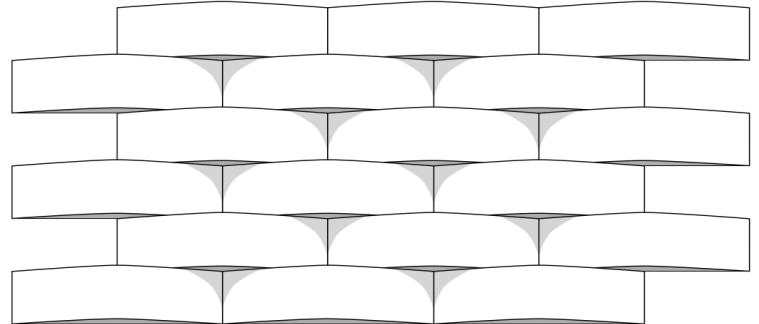

Brickset

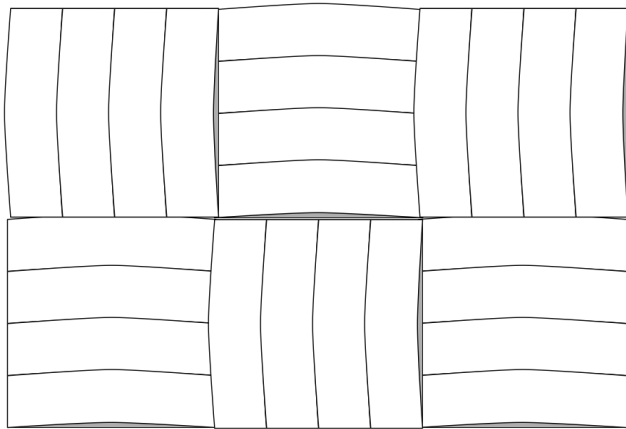

Basketweave

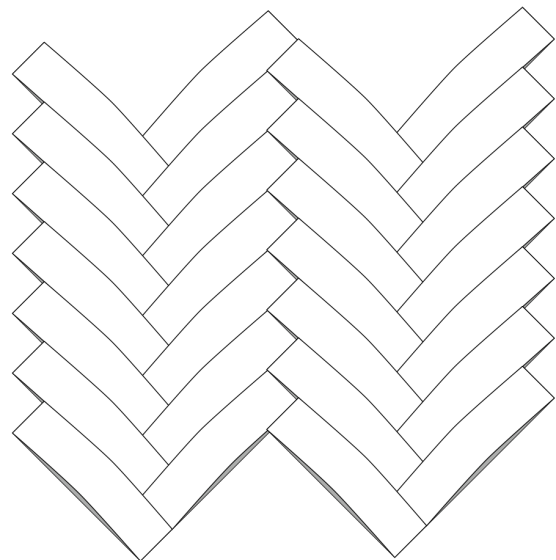

Herringbone

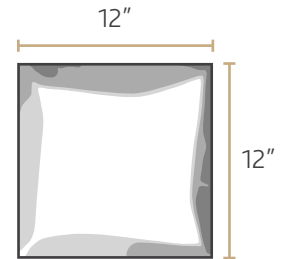
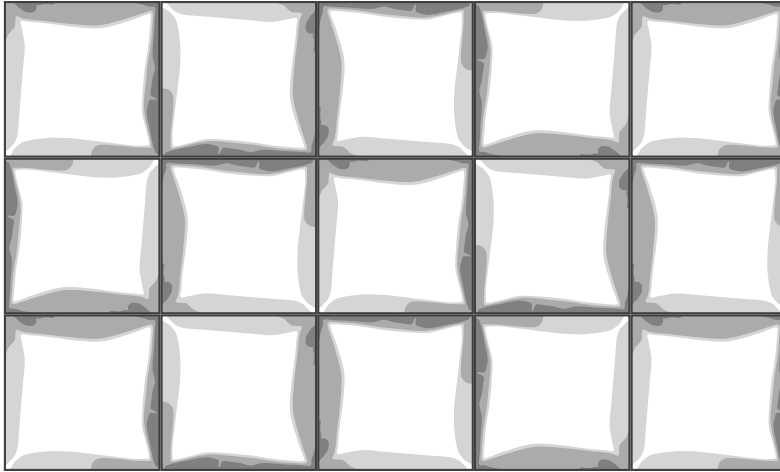

## Product Specifications

> **COVERAGE/TILE**

1 sf

> **THICKNESS**

7/16" to 1.5"

> **WEIGHT/CASE**

13 lbs

> **COVERAGE/CASE**

10 sf

> **WEIGHT/TILE**

1.20 lb

> **INSTALLATION**

For best results, download installation instructions at [www.verticalillusion.com](http://www.verticalillusion.com)

> **TILE SIZE**

12" x 12"

> **TILE/CASE**

10

**PRODUCT SAMPLE DISCLAIMER**

Created to be a one-of-a-kind piece of nature's artistry, each and every Vertical Illusion® product carries distinct variations in finish, patina, texture, grain and overall character that create the unique diversity and natural elegance of our wall coverings. It is virtually impossible to capture – in a small sample – the entire range of color variation and character that will be present in the wall covering you will receive. To better understand the unique look of a Vertical Illusion finished wall covering in your space, we recommend consulting your sales representative for more details.

**INSTALLATION AND PERFORMANCE DISCLAIMER**

Environmental conditions, such as exposure to light, and fluctuations in temperature and humidity, will greatly affect product performance from initial installation throughout its life. Refer to our website for installation guidelines or see your local sales representative for more information on proper steps and specific environmental conditions to successfully install, care for and ensure the lifelong performance of your wall covering.

Make it your Own! This tile has a variety of layout options. Here are some suggested installations.

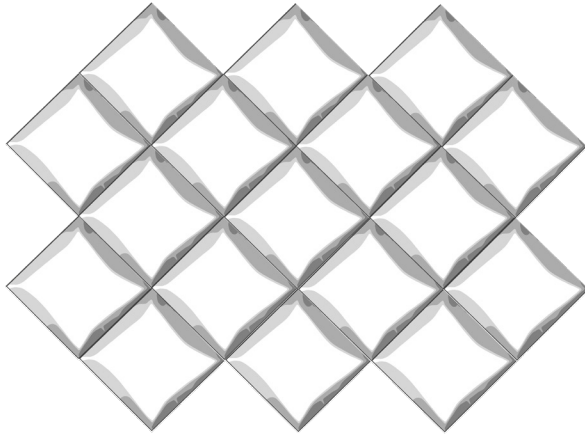

Directional

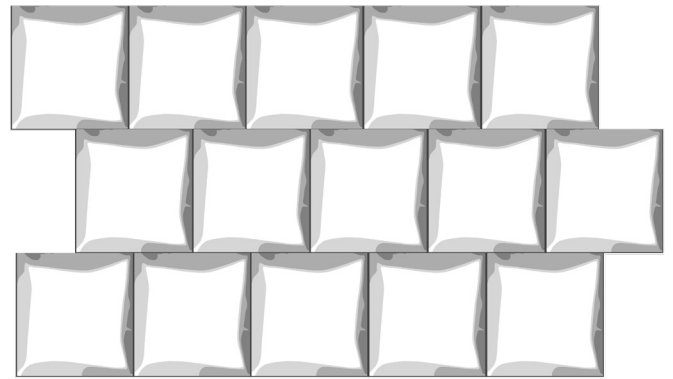

Brickset

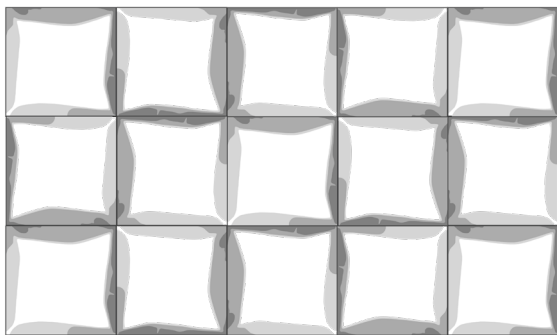

Stacked

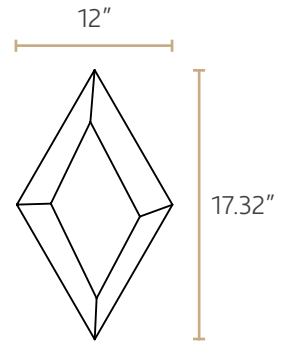
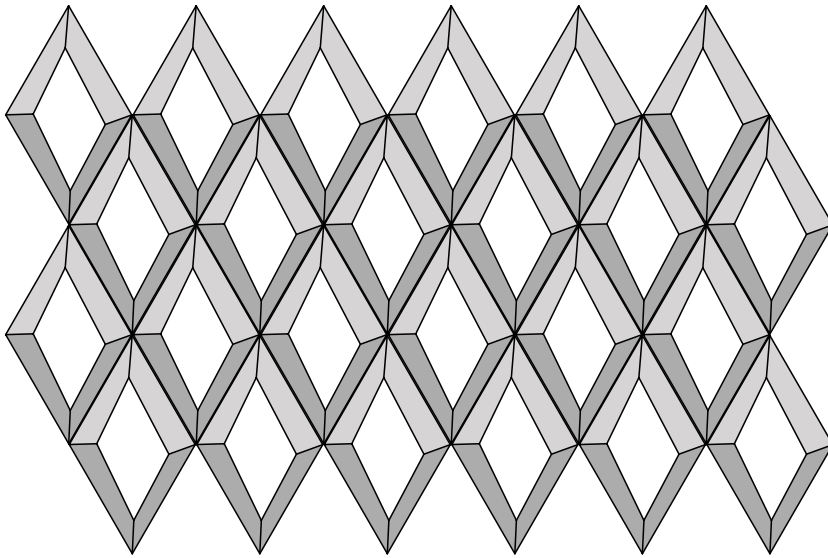

## Product Specifications

- > **COVERAGE/TILE**  
.60 sf
- > **THICKNESS**  
7/16" to 1.5"
- > **WEIGHT/CASE**  
20 lbs
- > **COVERAGE/CASE**  
14.4 sf
- > **WEIGHT/TILE**  
1 lb
- > **INSTALLATION**  
For best results, download installation instructions at [www.verticalillusion.com](http://www.verticalillusion.com)
- > **TILE SIZE**  
17.32" x 12"
- > **TILE/CASE**  
24

### PRODUCT SAMPLE DISCLAIMER

Created to be a one-of-a-kind piece of nature's artistry, each and every Vertical Illusion® product carries distinct variations in finish, patina, texture, grain and overall character that create the unique diversity and natural elegance of our wall coverings. It is virtually impossible to capture – in a small sample – the entire range of color variation and character that will be present in the wall covering you will receive. To better understand the unique look of a Vertical Illusion finished wall covering in your space, we recommend consulting your sales representative for more details.

### INSTALLATION AND PERFORMANCE DISCLAIMER

Environmental conditions, such as exposure to light, and fluctuations in temperature and humidity, will greatly affect product performance from initial installation throughout its life. Refer to our website for installation guidelines or see your local sales representative for more information on proper steps and specific environmental conditions to successfully install, care for and ensure the lifelong performance of your wall covering.

Make it your Own! This tile has a variety of layout options. Here are some suggested installations.

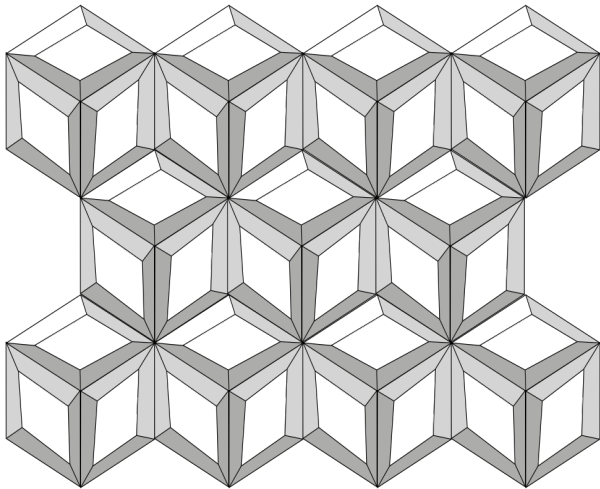

Radical

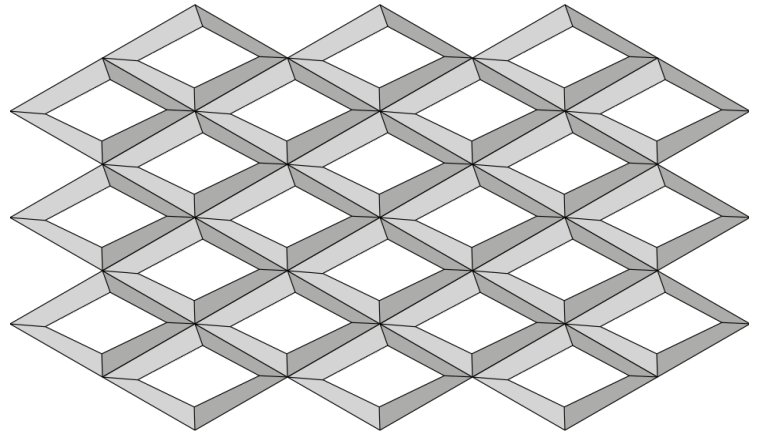

Stacked

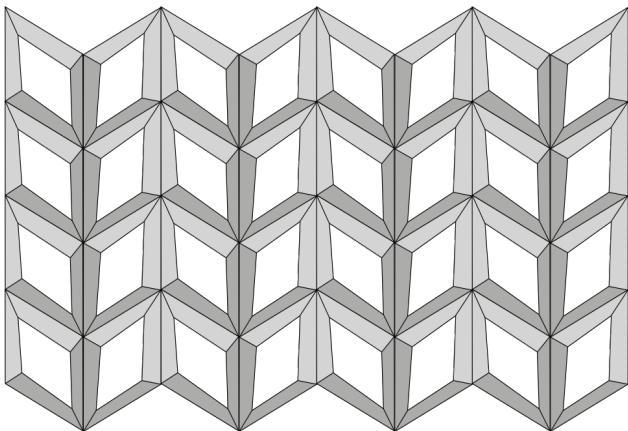

Chevron

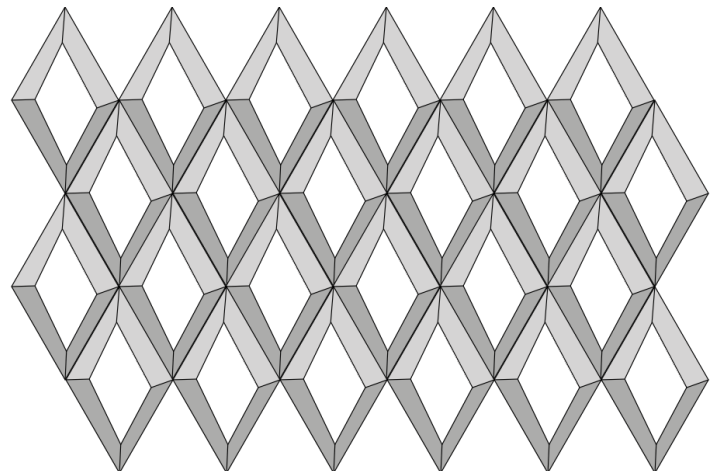

Directional

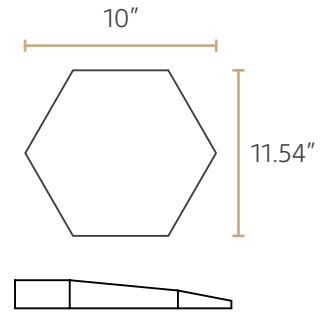
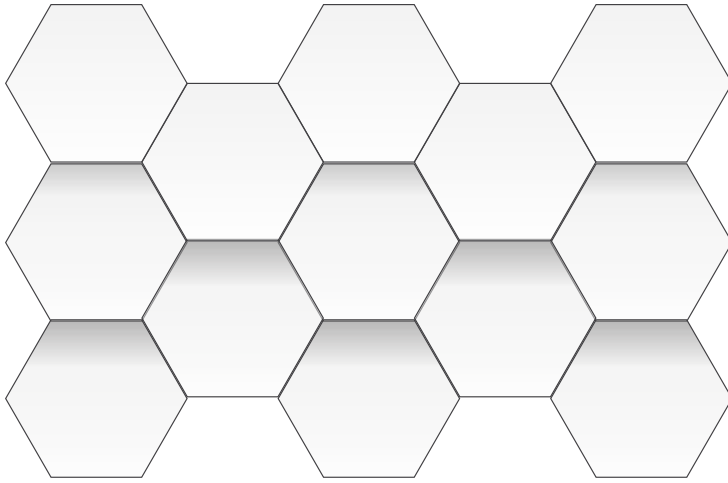

## Product Specifications

- > **COVERAGE/TILE**  
.60 sf
- > **THICKNESS**  
7/16" to 1.5"
- > **WEIGHT/CASE**  
24 lbs
- > **COVERAGE/CASE**  
16.8 sf
- > **WEIGHT/TILE**  
1 lb
- > **INSTALLATION**  
For best results, download installation instructions at [www.verticalillusion.com](http://www.verticalillusion.com)
- > **TILE SIZE**  
10" x 11.54"
- > **TILE/CASE**  
28

### PRODUCT SAMPLE DISCLAIMER

Created to be a one-of-a-kind piece of nature's artistry, each and every Vertical Illusion® product carries distinct variations in finish, patina, texture, grain and overall character that create the unique diversity and natural elegance of our wall coverings. It is virtually impossible to capture – in a small sample – the entire range of color variation and character that will be present in the wall covering you will receive. To better understand the unique look of a Vertical Illusion finished wall covering in your space, we recommend consulting your sales representative for more details.

### INSTALLATION AND PERFORMANCE DISCLAIMER

Environmental conditions, such as exposure to light, and fluctuations in temperature and humidity, will greatly affect product performance from initial installation throughout its life. Refer to our website for installation guidelines or see your local sales representative for more information on proper steps and specific environmental conditions to successfully install, care for and ensure the lifelong performance of your wall covering.

Make it your Own! This tile has a variety of layout options. Here are some suggested installations.

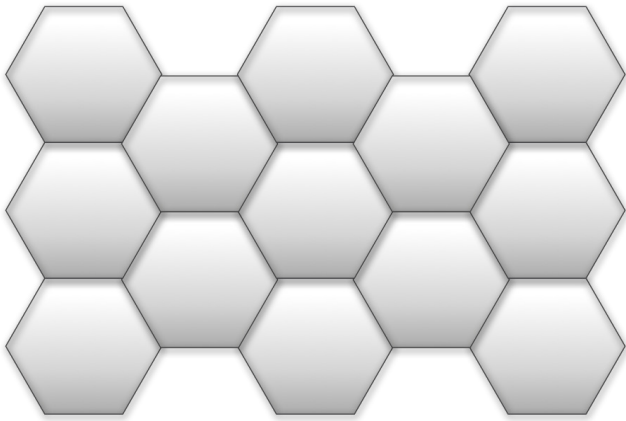

Directional

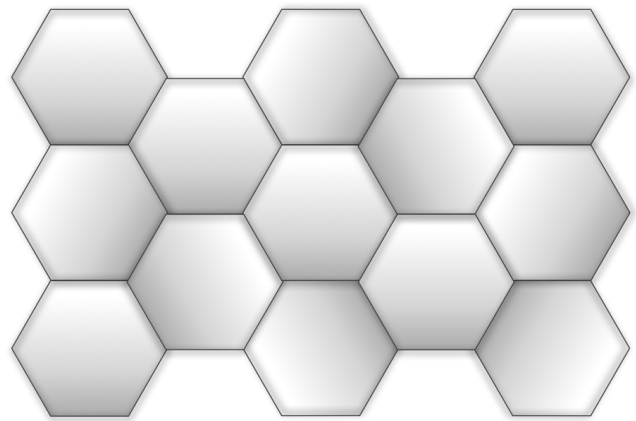

Random

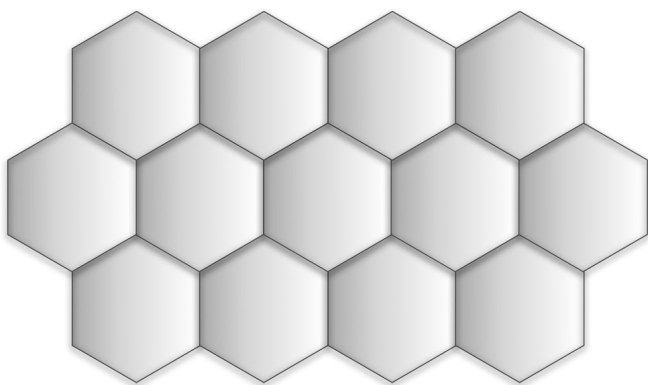

Rotated

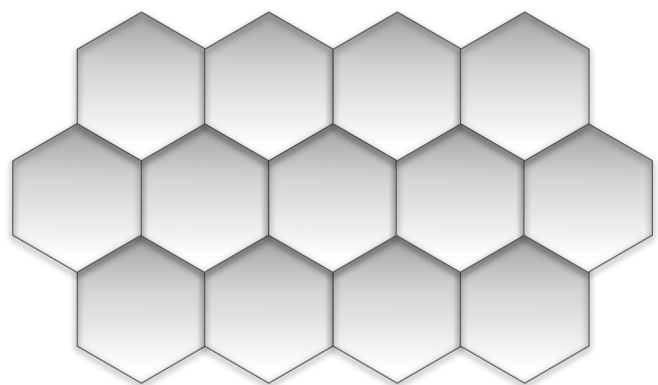

Inverted

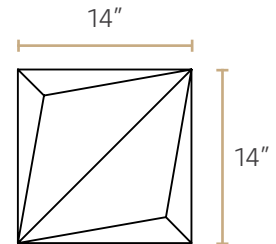
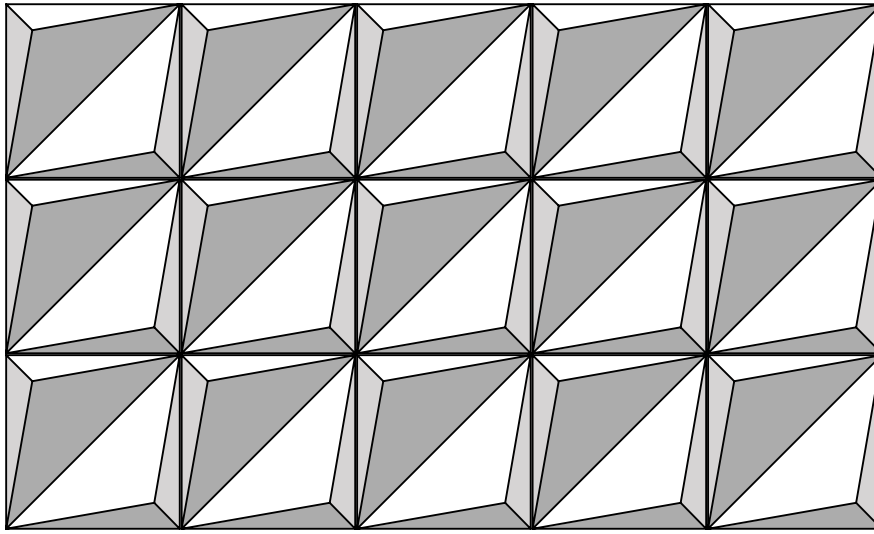

## Product Specifications

- > **COVERAGE/TILE**  
1.36 sf
- > **THICKNESS**  
7/16" to 2"
- > **WEIGHT/CASE**  
19 lbs
- > **COVERAGE/CASE**  
13.61 sf
- > **WEIGHT/TILE**  
1.5 lb
- > **INSTALLATION**  
For best results, download installation instructions at [www.verticalillusion.com](http://www.verticalillusion.com)
- > **TILE SIZE**  
14" x 14"
- > **TILE/CASE**  
10

### PRODUCT SAMPLE DISCLAIMER

Created to be a one-of-a-kind piece of nature's artistry, each and every Vertical Illusion® product carries distinct variations in finish, patina, texture, grain and overall character that create the unique diversity and natural elegance of our wall coverings. It is virtually impossible to capture – in a small sample – the entire range of color variation and character that will be present in the wall covering you will receive. To better understand the unique look of a Vertical Illusion finished wall covering in your space, we recommend consulting your sales representative for more details.

### INSTALLATION AND PERFORMANCE DISCLAIMER

Environmental conditions, such as exposure to light, and fluctuations in temperature and humidity, will greatly affect product performance from initial installation throughout its life. Refer to our website for installation guidelines or see your local sales representative for more information on proper steps and specific environmental conditions to successfully install, care for and ensure the lifelong performance of your wall covering.

Make it your Own! This tile has a variety of layout options. Here are some suggested installations.

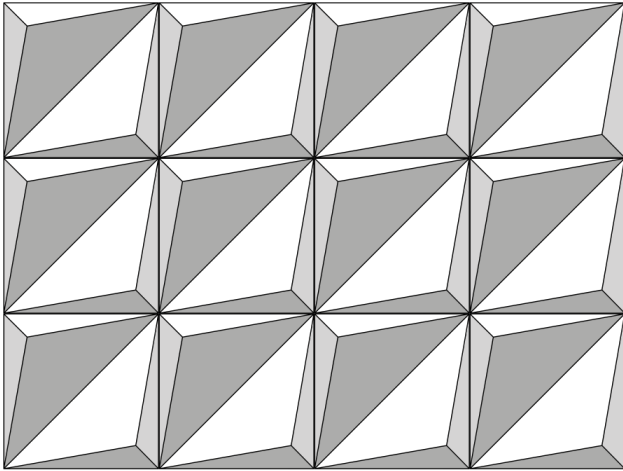

Directional

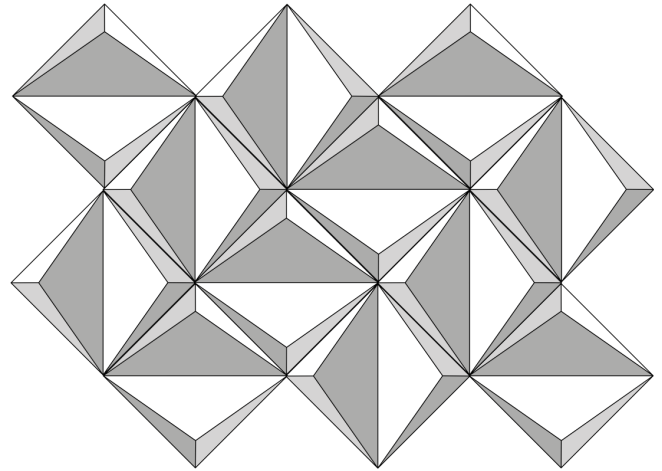

Alternating Diagonal

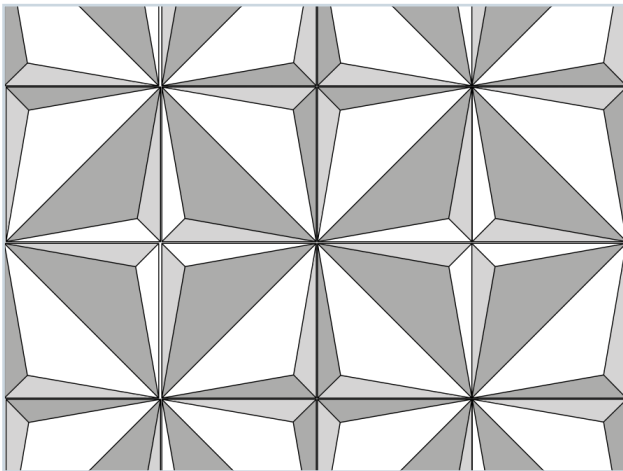

Star

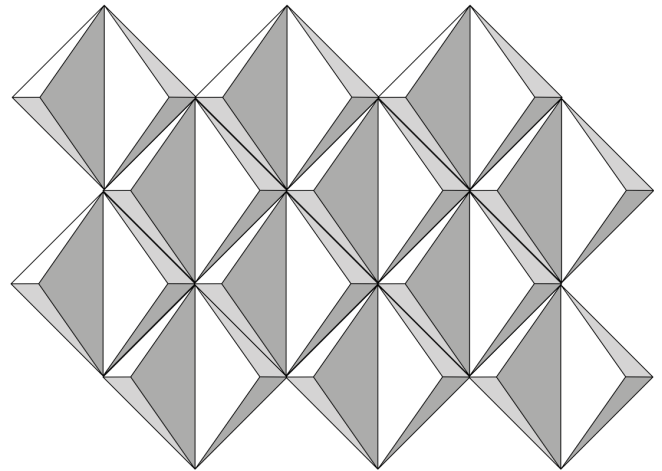

Directional Diagonal

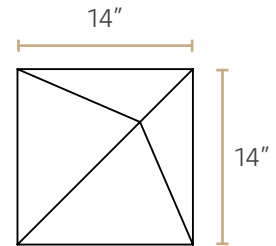
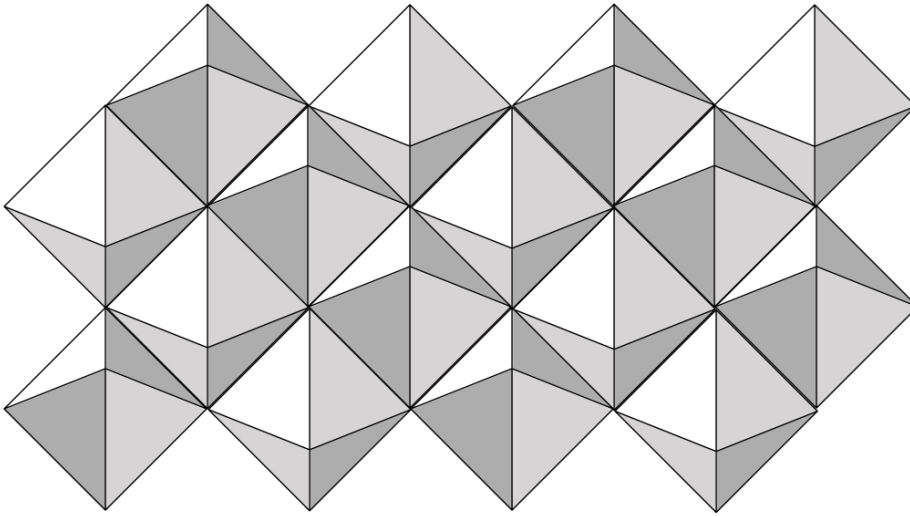

## Product Specifications

> **COVERAGE/TILE**

1.36 sf

> **THICKNESS**

7/16" to 2"

> **WEIGHT/CASE**

16 lbs

> **COVERAGE/CASE**

13.61 sf

> **WEIGHT/TILE**

1.25 lb

> **INSTALLATION**

For best results, download installation instructions at [www.verticalillusion.com](http://www.verticalillusion.com)

> **TILE SIZE**

14" x 14"

> **TILE/CASE**

10

**PRODUCT SAMPLE DISCLAIMER**

Created to be a one-of-a-kind piece of nature's artistry, each and every Vertical Illusion® product carries distinct variations in finish, patina, texture, grain and overall character that create the unique diversity and natural elegance of our wall coverings. It is virtually impossible to capture – in a small sample – the entire range of color variation and character that will be present in the wall covering you will receive. To better understand the unique look of a Vertical Illusion finished wall covering in your space, we recommend consulting your sales representative for more details.

**INSTALLATION AND PERFORMANCE DISCLAIMER**

Environmental conditions, such as exposure to light, and fluctuations in temperature and humidity, will greatly affect product performance from initial installation throughout its life. Refer to our website for installation guidelines or see your local sales representative for more information on proper steps and specific environmental conditions to successfully install, care for and ensure the lifelong performance of your wall covering.

Make it your Own! This tile has a variety of layout options. Here are some suggested installations.

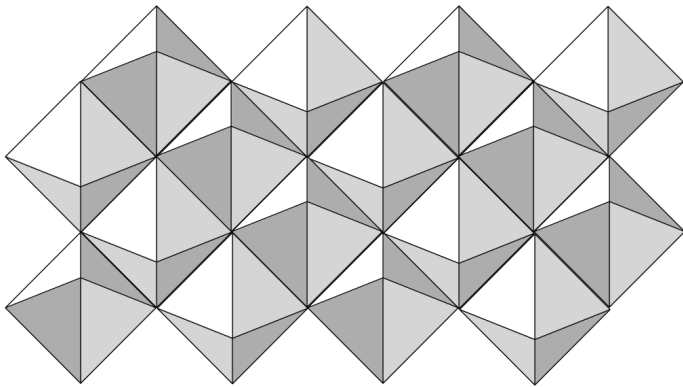

Random

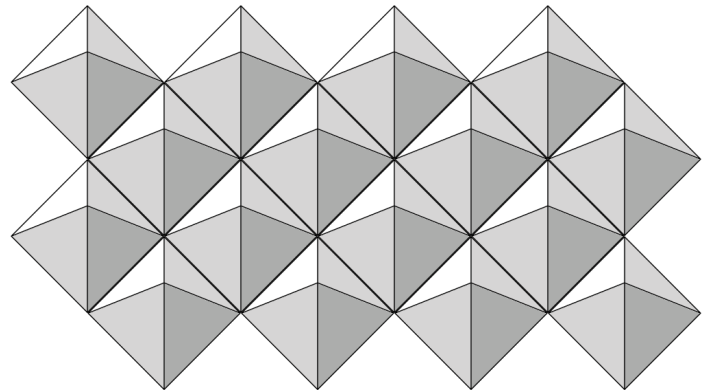

Diagonal

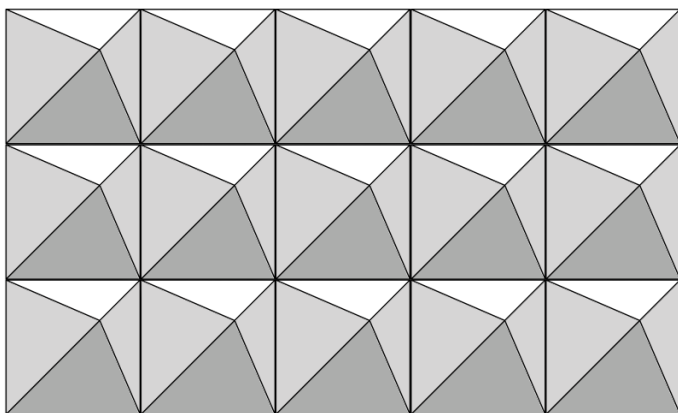

Radial

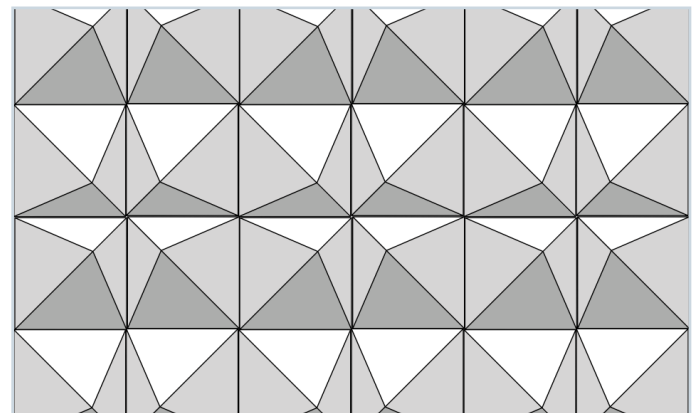

Star



Charred Cedar

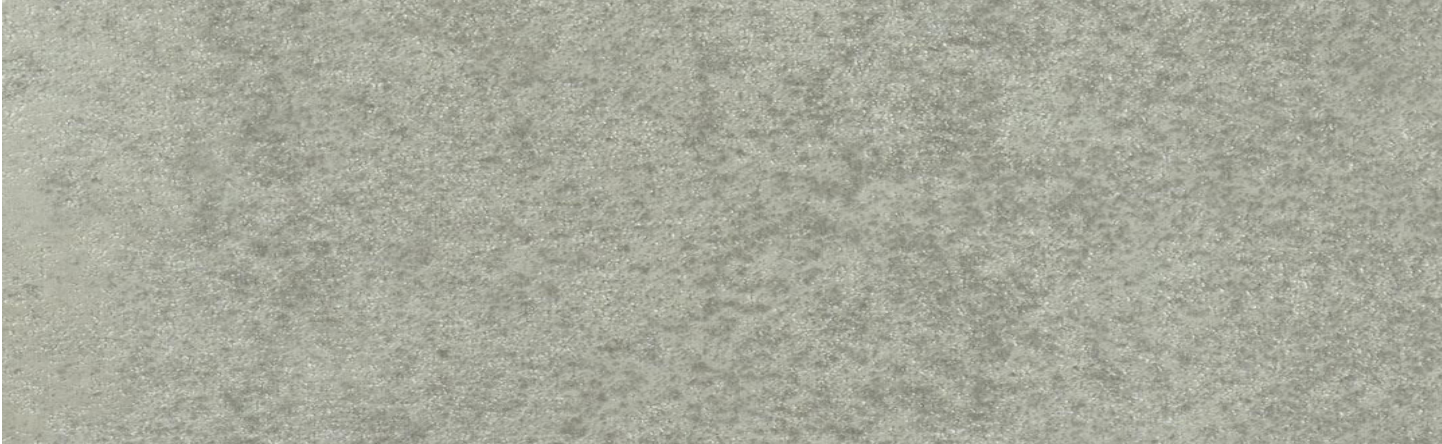

Concrete Mixt Grey



Concrete Urban Grey



Copenhagen Alabaster



Copenhagen Gray



Copenhagen Natural



Copenhagen Taupe



Craft Hickory Grey



Craft Hickory Natural



Mercury Noir



Metro Fresco



Oxford Casual Taupe



Oxford Mellow White



Oxford Slate



Raintree Diamond



Raintree Mink



Raintree Spinel



Riverside Clove



Shenandoah Bark



Shenandoah Dove

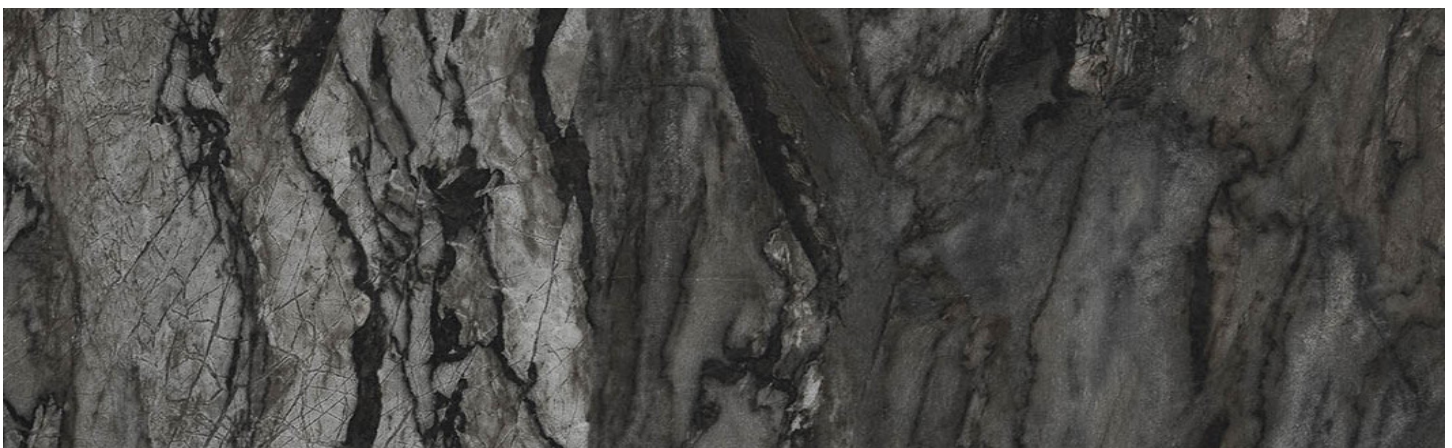

Shenandoah Graphite



Shenandoah Bone



Southwester

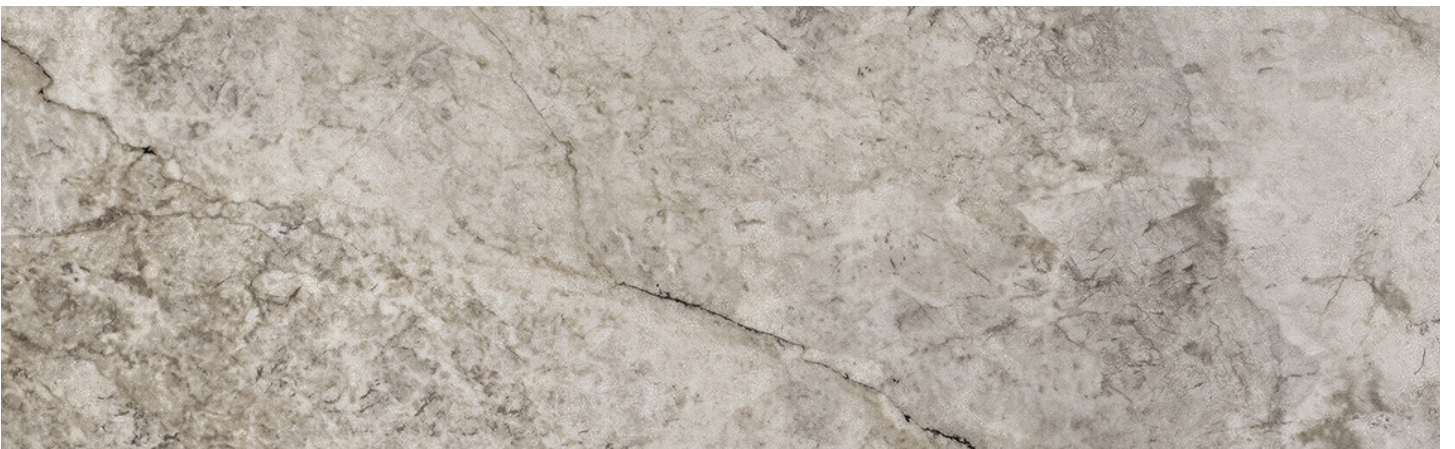

Venetian Brandy



Venetian Flax



Venetian Frost

## Additional Colors

---

> Available upon request.

**Step One: Choose a Shape**

> Add new depth to your project with seven crisp geometric shapes featuring dimensional angles and curves

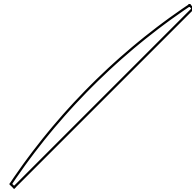

Convex

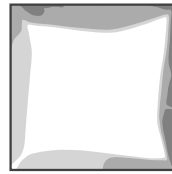

Quad

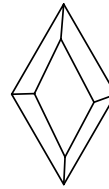

Rhom

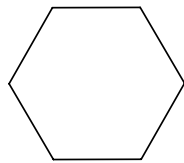

Slant

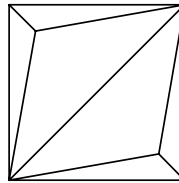

Vale

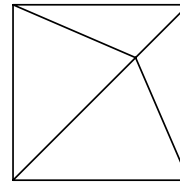

Vertex

**Step Two: Select a Finish**

> Our curated collection of finishes includes rich woodgrains, textured solids, metals, and concrete.



Charred Cedar



Concrete Mixt Grey



Concrete Urban Grey



Copenhagen Alabaster



Copenhagen Gray

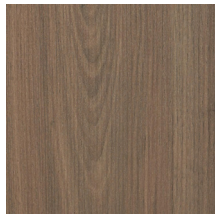

Copenhagen Natural

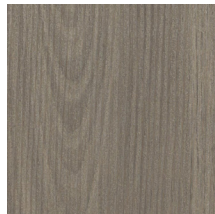

Copenhagen Taupe



Craft Hickory Grey



Craft Hickory Natural



Mercury Noir



Metro Fresco

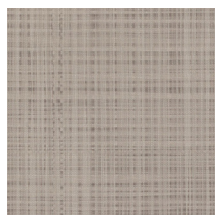

Oxford Casual Taupe



Oxford Mellow White

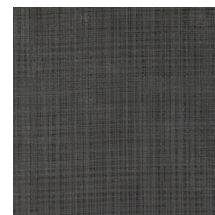

Oxford Slate Black



Raintree Diamond



Raintree Mink



Raintree Spinel



Riverside Clove



Shenandoah Bark



Shenandoah Bone



Shenandoah Dove



Shenandoah  
Graphite



Southwester



Venetian Brandy



Venetian Flax



Venetian Frost

### Step Three: Pick a Pattern

---

- Each shape has the ability to be tiled in a multitude of patterns, from classic to avant garde, allowing for design flexibility and creativity.

Example:

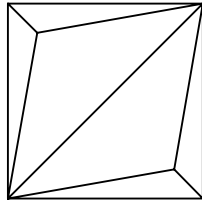

Vale

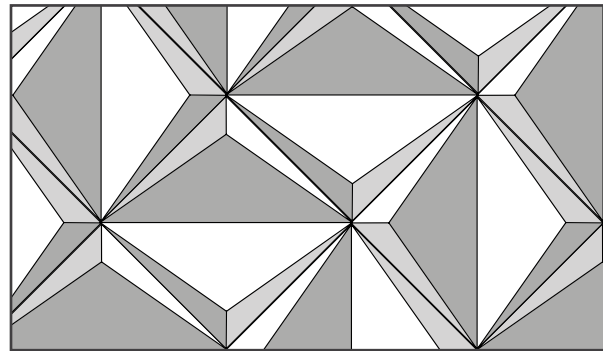
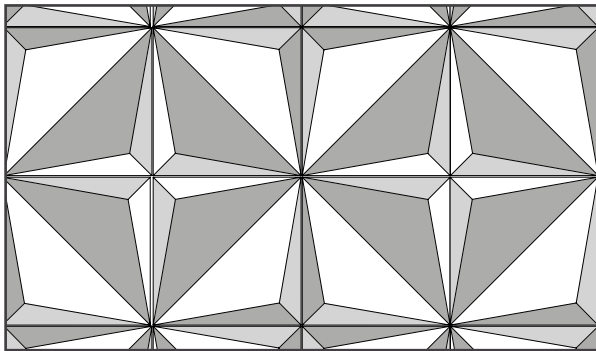
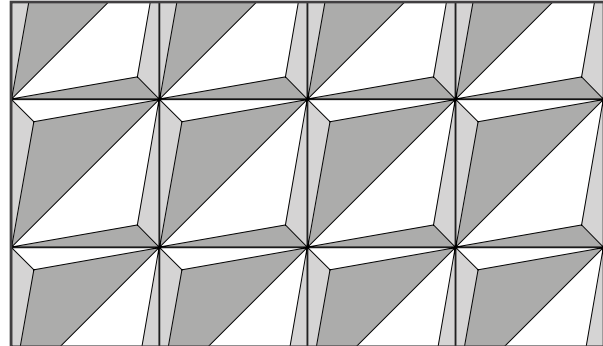

### Step Four: Request a Sample or Quote

---

- Calculate how many cases you will need in your chosen shape and finish, then give us a call.
- Call **602-788-0662** or email [orders@verticalillusion.com](mailto:orders@verticalillusion.com) to request a sample or get a quote.

**Trim**

> Trim for installation is available in both aluminum and gunmetal

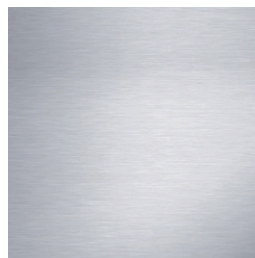
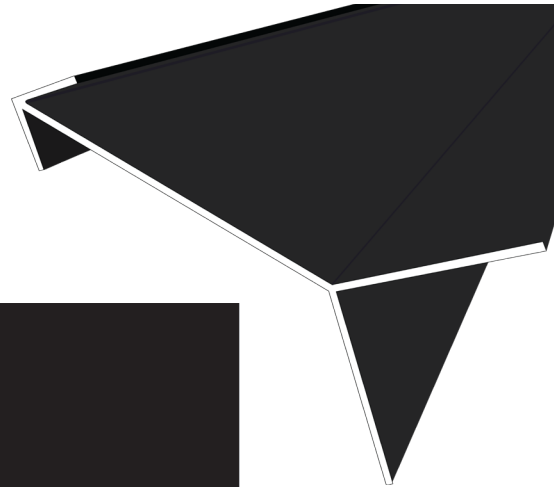
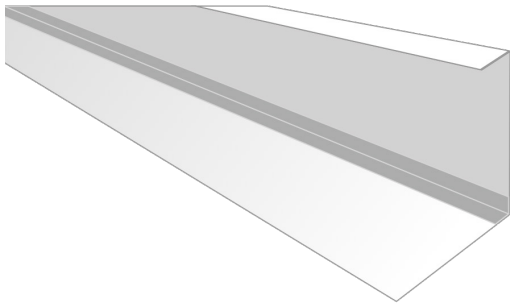

Aluminum

Gunmetal

**Switch Box**

> Single, double, and triple outlet box extensions are available in any finish.

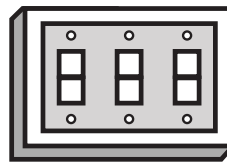
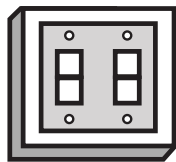
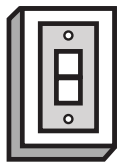

> 3 7/8" x 5 1/4" x 1 1/2"

> 5 1/2" x 5 1/4" x 1 1/2"

> 7 1/2" x 5 1/4" x 1 1/2"

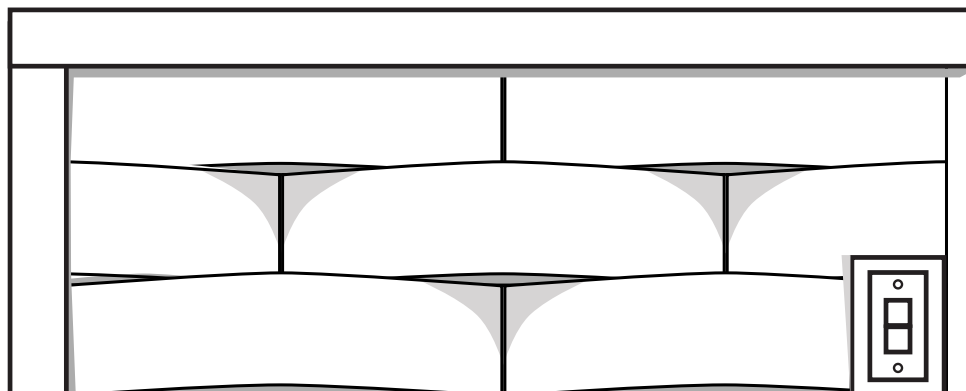

## What You'll Need

- > Measuring tape
- > Pencil
- > Level
- > Chalkline
- > Recommended adhesive: quality poly modified mortar or equivalent adhesive
- > 1/8" notch trowel
- > Saw (wet or dry, chop saw, table saw, coping saw or wood saw)
- > Ladder

## Getting Started

- > Open and inspect your order immediately upon arrival for any damage caused during shipping.
- > Vertical Illusion products are handmade and that makes them different from other products. Any perceived imperfections are part of that uniqueness and are inherent in the design. Not all edges are perfectly straight and some gapping (1/16") between parts will be present. Vertical Illusion parts undergo extreme heat & pressure during the finishing process which creates a slightly warped back surface. This nuance doesn't affect the installation provided the installer is aware and uses more adhesive on the areas that don't sit flush to the substrate.
- > If the color of the wall is not a color that you want to see between the parts, you will need to paint the wall a matching tone prior to installing your Vertical Illusion wall.

## Plan Your Layout

- > **Start on the floor!** Lay out a full case of material on the floor until you find a pattern that best fits your space. There's no wrong way. Begin with a traditional pattern - for example, a brickset. Then try shifting the vertical lines randomly to avoid the repetitive pattern of the brickset. This creates an entirely different approach and increases the visual allure as the shadows will be randomized.

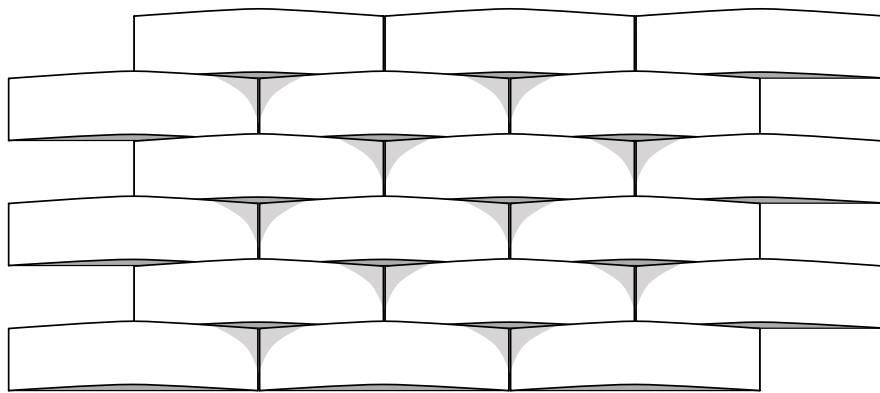

Typical Brickset

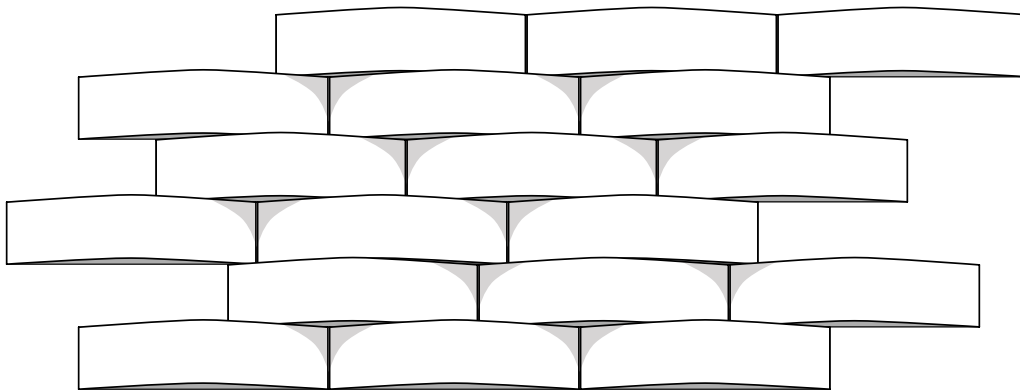

Random Brickset

- > Get familiar with the Vertical Illusion part and dimension. Begin by marking the vertical centerline and the horizontal centerline on the wall. Work away from the centerlines to identify where cuts or small parts will fall.

## Plan Your Layout Continued

- We find that once furniture is placed, the bottom of each wall becomes the least visual line, therefore we recommend beginning with full or half piece parts at the top and work your way down.
- START/STOP TRIM STICKS: We have trim that allows the product to work with inside and outside corners. It can also act as a picture frame completely trimming out all four sides of your feature wall.
- LIGHT SWITCHES AND OUTLETS: We have block out parts for all electrical. Single, double even triple gang boxes.

Install the block out box before installing product. Once the block out box is secure, the product can be cut around the boxes, giving your wall a designer finish. Depending on how clean your cuts are, you might want to use a flexible caulk that is similar in color to reduce any uneven lines.

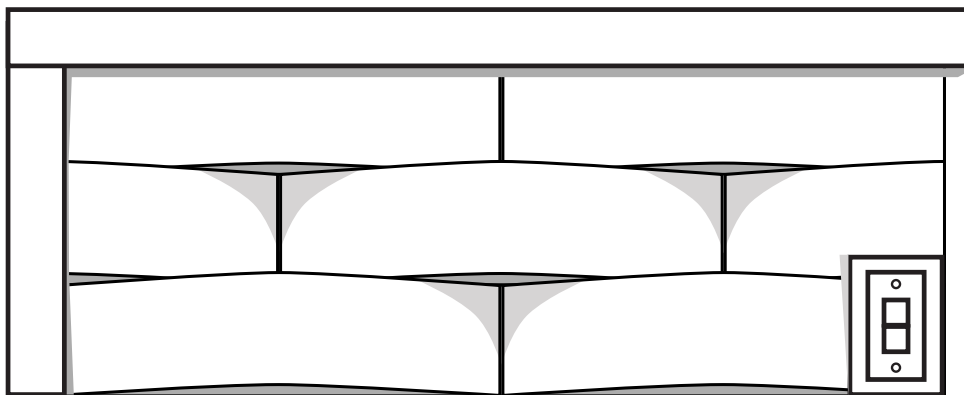

- DISCLAIMER: Approved electrical extension rings must be installed when using Vertical Illusion block out boxes.

## Ready to Install

- If you haven't yet, now is the time to use the chalkline to mark a grid of vertical and horizontal lines on the wall to keep the pattern from meandering.
- Use proper interior polymer mortar adhesive.
- Using the 1/8" notch trowel, apply the approved adhesive directly to the Vertical Illusion part or to the substrate (wood, concrete, and drywall are all acceptable substrates).
- Apply pressure until part is firmly secured to the wall.
- There are many methods of cutting Vertical Illusion parts: you can use a chop saw, table saw, wet saw, coping saw, or wood saw, it's up to you!
- BATHROOM/KITCHEN: Vertical Illusion products may be used in these environments provided the products are not installed directly in a wet area.

## Disclaimers:

- When cutting Vertical Illusion tiles, always cut from top/front to the back/bottom. This will preserve the integrity of the tile's finish.
- When installing around a fireplace, be aware that the finishing process requires a heat activated adhesive which will fail if installed around a heat source. Check manufactures guidelines regarding distance from firebox to avoid heat damage to the product.
- **Do not use** nails or screws to attach product to wall.

## Recommendations

The following are guidelines and recommendations to keep your Vertical Illusion walls beautiful. Our pre-finished products use the highest quality 3D laminate material that creates the illusion of reality. Our State of the Art Laminating process results in a seamless surface that looks real but is extremely resistant to chipping, cracking and most household chemicals. For easy cleanup, just wipe with a damp cloth and a mild detergent.

Clean all spills immediately using a soft cloth and clear water. The surface resists many common household substances, and most will wipe clean with a damp cloth or sponge.

Remove oil, grease, or other general soil that does not respond to water alone with a non-abrasive cleaner. Tough stains may be cleaned using a soft cloth dampened with a "409" or "Simple Green" type cleanser. However, cleaners with acetone, ethyl alcohol or mineral oils should not be used.

**Do not** use harsh detergents, abrasive cleaners, or bleach, as these substances can damage the laminate surface and impair its protective qualities.

**Do not** use your dishcloth to clean or dry the product. It may contain remnants of detergents and grease.

**Do not** wax or polish the finish surface.

A spray type furniture polish may be used after cleaning to remove any streaking and enhance the color of the finish, especially wood grains.

Keep Vertical Illusion products out of direct sunlight or close curtains during the sunniest part of the day. Direct sunlight will cause the finish to lighten or darken over time.

Avoid exposing the products to very hot environments (130 degree F max). Extreme heat can cause the finish to delaminate or peel.

Vertical Illusion requires a purchase order for all orders and sample requests. Purchases should be emailed to [orders@verticalillusion.com](mailto:orders@verticalillusion.com). No material will be released without a purchase order.

All goods should be inspected within 48 hours of receipt. Failure to notify Vertical Illusion of any discrepancies within 48 hours will be deemed acceptance of goods. While we will make every attempt to correct the situation, if discrepancies are not reported within 48 hours of receipt, Vertical Illusion reserves the right to charge for the replacement product and any associated shipping costs.

If an error has occurred, any required replacement material will be sent out in the same manner that the original order was sent. It will not be shipped next day air or in an expedited fashion unless the customer is willing to accept the charges for such.

Part of the inherent beauty of the Vertical Illusion product is that coloring, veining, and shading is unique on each piece. All materials should be inspected carefully before installation, and must be blended to ensure a more equal distribution of any possible variations. Veining and shade variation is not considered a product defect. **No claims will be accepted for any reason after material is installed.**

All prices are from our Phoenix warehouse. Residential fees apply to shipments to a non-commercial address.

Vertical Illusion reserves the right to change pricing, terms and conditions of any sale without prior notice.

Vertical Illusion recommends that only licensed, bonded, and knowledgeable installers do any work that may be required to install any of our products. Vertical Illusion is only a supplier and even if we should recommend any installers, it is up to the client/contractor to decide what is best for them. Vertical Illusion doesn't assume any liability for the installation of products.

**In the event that you arrange your own shipping, Vertical Illusion isn't liable for any damages that may occur but does insure that all goods will leave in good condition. Clients have the right to inspect any merchandise before it leaves our warehouse. Also, we recommend approving your pallets before they leave.**

All orders must be picked up within 21 days from the time of placing the order or they will be returned to stock. Please advise us at the time of place the order if you require additional time.

### Payment Terms

- > All payment is due upon receipt, unless an account has been opened in advance with our credit department.
- > Any account going past 60 days, will forfeit any credit terms and require COD on any orders.
- > All Checks are subject to a return check fee.

### Return of Material

- > Vertical Illusion products are custom made for each order, and therefore we are not able to accept returns on this product.

This Limited Warranty applies to physical goods, and only for physical goods, purchased from Vertical Illusion (the "Physical Goods"). The Limited Warranty follows the product for a period of 1 year from the original date of purchase, regardless of when the product is installed.

#### **What does this limited warranty cover?**

Our Limited Warranty covers any defects in material or workmanship under normal use during the Warranty Period. Vertical Illusion will replace, at no charge, products or parts of a product that prove defective because of improper material or workmanship, under normal use and maintenance. The Limited Warranty will be void in the event the product was not installed according to our installation guidelines.

This Limited Warranty is transferable, but still applies from the date of the original purchase.

#### **What will we do to correct problems?**

If a Product is found defective, Vertical Illusion will replace the Product at no charge. Replacement Product will be shipped in the same manner as the original purchase.

#### **How long does the coverage last?**

The Warranty Period for Physical Goods purchased from Vertical Illusion is 1 Year from the date of purchase. A replacement Physical Good or part assumes the remaining warranty of the original Physical Good or 1 Year from the date of replacement or repair, whichever is longer.

#### **What does this limited warranty not cover?**

This Limited Warranty does not cover any problem that is caused by:

Conditions, malfunctions or damage not resulting from defects in material or workmanship Conditions, malfunctions or damage resulting from negligence, improper installation or maintenance.

Vertical Illusion will pay for shipping charges on replacement parts.

Provided Vertical Illusion ships the order, Vertical Illusion shall assume all risk of damage to the Physical Goods while in transit to our customer. Vertical Illusion assumes no liability for damage in transit if shipment is not arranged by Vertical Illusion.

#### **What do you have to do?**

To obtain warranty service, you must obtain a Return Merchant Authorization (RMA) number and instructions on how to return a product by contacting us. Deliver the Physical Goods, in either its original packaging or comparable packaging, including any accessories or documents that shipped with the Physical Goods to the address specified by Vertical Illusion. To obtain the Return Merchant Authorization (RMA) number, you can contact us by any of the following contact methods:

Email: [info@verticalillusion.com](mailto:info@verticalillusion.com)

#### **Implied Warranties**

EXCEPT TO THE EXTENT PROHIBITED BY APPLICABLE LAW, ALL IMPLIED WARRANTIES (INCLUDING WARRANTIES OF MERCHANTABILITY AND FITNESS FOR A PARTICULAR PURPOSE) SHALL BE LIMITED IN DURATION TO THE DURATION OF THIS LIMITED WARRANTY.

#### **Limitation of Damages**

EXCEPT TO THE EXTENT PROHIBITED BY APPLICABLE LAW, VERTICAL ILLUSION SHALL NOT BE LIABLE FOR ANY INCIDENTAL, INDIRECT, SPECIAL, OR CONSEQUENTIAL DAMAGES RESULTING FROM ANY BREACH OF EXPRESS OR IMPLIED WARRANTY OR CONDITION, OR UNDER ANY OTHER LEGAL THEORY.

#### **Consumer Protection**

Some states do not allow the exclusion or limitation of incidental or consequential damages, or allow limitations on how long an implied warranty lasts, so the above limitations or exclusions may not apply to you. This warranty gives you specific legal rights, and you may also have other rights that vary by state to state.

#### **Governing Law**

This Limited Warranty shall be governed by the laws of Arizona, United States without giving effect to any conflict of laws principles that may provide the application of the law of another jurisdiction.

Vertical Illusion  
2514 East Mohawk Lane Suite #103  
Phoenix, Arizona 85050  
Phone: 602-788-0662  
Email: info@verticalillusion.com

1. Product Identification
  - a. Rigid polyurethane decorative part by Vertical Illusion
2. Hazards Identification
  - a. Primary routes of entry include: inhalation, skin contact, eye contact or ingestion
  - b. Medical conditions aggravated by exposure: respiratory disorders
3. Human Effects and Symptoms of Overexposure
  - a. Skin – contact with moist skin may produce some very slight irritation due to alkalinity and/or mechanical irritation
  - b. Eye – dust may cause mechanical irritation
  - c. General Effects of Exposure – repeated or prolonged eye and/or skin contact with dust generated from part when cutting may produce a dehydrating effect
  - d. Carcinogenicity – no carcinogenic substances as defined by iarc, ntp and/or osha
4. First Aid Measures
  - a. Eye Contact – in case of contact with dust from this product, flush eyes with plenty of lukewarm water. Get medical attention if irritation develops.
  - b. Skin Contact – get medical attention if irritation develops.
  - c. Inhalation – move to fresh air in case of accidental inhalation of dust or fumes from overheating or combustion. Get medical attention if irritation develops.
  - d. Ingestion – if ingested, do not induce vomiting unless directed to do so by medical personnel. Get medical attention.
5. Fire Fighting Measures
  - a. Suitable Extinguishing Media – water, foam, dry chemical
6. Handling and Storage
  - a. Avoid creating dust, wash thoroughly after handling
  - b. Keep away from heat, sparks and open flames
7. Exposure Controls – personal protection
  - a. Industrial Hygiene/Ventilation Measures - none required under normal conditions of use. During cutting/sanding, local exhaust ventilation should be used to maintain the dust levels below the exposure limit for nuisance particulates.
  - b. Respiratory Protection – none required under normal conditions of use. During cutting/sanding, a respirator may be used to control nuisance dust inhalation. Any time nuisance dust standards are exceeded a particulate respirator is required.
  - c. Hand Protection – none required under normal conditions of use. Those with sensitive skin should use canvas or cloth gloves.
  - d. Eye Protection – safety glasses with side-shields
  - e. Skin and Body Protection – none required under normal handling and use.
  - f. Additional Protective Measures – after install, wash hands and face before eating, drinking or using tobacco products. Educate and train employees in the safe use and handling of this product.
8. Physical and Chemical Properties
  - a. Form Solid
  - b. Color Characteristic
  - c. Odor Not Applicable
  - d. PH Not Applicable
  - e. Boiling Point Not Applicable
  - f. Flash Point Not Applicable
  - g. Solubility in Water Insoluble
9. Stability and Reactivity
  - a. Hazardous Reactions Hazardous polymerization does not occur
  - b. Stability Stable
  - c. Material to Avoid None Known
  - d. Conditions to Avoid None Known
10. Disposal Considerations
  - a. Waste disposal should be in accordance with existing federal, state and local environmental control laws.
11. Regulatory Information
  - a. OSHA HAZCOM Standard Rating – Non Hazardous
  - b. US EPA CERCLA Hazardous Substance – None
  - c. SARA Section 311-312 – Non Hazardous
  - d. California Prop 65 – to the best of our knowledge, this product does not contain any of the listed chemicals, which the state of California has found to cause cancer, birth defects or other reproductive harm.



Convex - Oxford Slate



Vale - Shenadoah Bark



Rhom - Copenhagen Alabaster



Rhom - Copenhagen Natural



Vale - Charred Cedar



Vertex - Corten Metal



# VERTICAL ILLUSION

---

[www.verticalillusion.com](http://www.verticalillusion.com)

602-788-0662

2514 East Mohawk Lane, Suite 103,  
Phoenix, Arizona 85050

[info@verticalillusion.com](mailto:info@verticalillusion.com)



Scan for **Vertical Illusion**